



SIMONI

INNOVATION SYSTEMS



Owner: Support Team (Nadav.N)
Support.Jig@simoniy.com

User Manual
SIMONI JIG



Table of Contents

Table of Contents	1
Table of Figures	2
Table of Tables.....	3
1 Introduction.....	4
2 Jig Legend	5
2.1 Jig Explorer parts	5
2.2 Jig Explorer Table.....	7
3 Safety Guide	9
3.1 General Instruction.....	9
3.2 *IMPORTANT SAFETY INSTRUCTIONS*	9
3.3 Work area Safety	9
3.4 Electrical Safety	10
3.5 Personal Safety.....	10
3.6 Power tool use and care.....	11
3.7 Service	12
3.7.1 Recent version	13
3.7.2 Additional Tools.....	14
3.7.3 Chemical/cleaning liquid	14
3.7.4 Using Third-party working tools.....	14
4 Product Specific Warnings.....	16
4.1 Saw Table, general instruction	16
4.2 SIMONI Jig instruction	17
4.3 SIMONI Jig Note and Tips	18
5 Video User Guide.....	19
6 Out Of Box Assembly.....	20
6.1 Assembly recommended tools.....	20
6.2 What you have inside the BOX.....	21
6.3 Leading Rail Adjustment.....	23
6.4 SIMONI Jig Position.....	25
6.5 Hand Fence	26
6.6 Material Holding Plate Assembly	27
6.7 Linear Fence Assembly	28
7 How to Clamp	29
8 Application explorer.....	32
8.1 General introduction	32
8.2 Application connection.....	32
8.3 Calibration process	34
8.3.1 Saw Blade Measure	34
8.3.2 Zero Point Calibration.....	35

8.4	Start to cut.....	39
8.5	Start to cut.....	42
8.6	Software upgrade and verify the latest FW version.....	44
8.7	LED indication.....	45
9	Troubleshooting and contact	47
9.1	LED indication.....	Error! Bookmark not defined.
9.2	How to contact, our address and feedback.....	48

Table of Figures

Figure 1: – Simoni Jig	4
Figure 2: – List of the Jig parts (front)	5
Figure 3: – List of the Jig parts (Electric Box Front and Rear)	5
Figure 4: – List of the Jig parts (Electric Box)	6
Figure 5: – Example of how to lay down the Jig on the cutting table	6
Figure 6: – Video User Manual and Support QR code	19
Figure 7: – 90-degree square tool	20
Figure 8: – Caliper	20
Figure 9: – leading rail, Adjustment	24
Figure 10: – SIMONI Jig body 90° setup.....	25
Figure 11: – SIMONI Jig body 90° calibrations done	26
Figure 12: – How to assembly the Hand Protection	26
Figure 13: – close knob and straight line with the SIMONI Jig frame	27
Figure 14: – verify Material Holding plate' is above the cutting blade.....	28
Figure 15: – linear fence assembly.....	28
Figure 16: – incorrect Clamp, under the JIG body	29
Figure 17: – Correct Clamp, several Method	30
Figure 17: – Correct Clamp, clamp have wood , change the clamp bar	31
Figure 18: – forget your auto-connected network	32
Figure 19: – SIMONI network selected and set for auto-reconnect	32
Figure 20: – SIMONI APP to scan.....	33



Figure 21: – SIMONI APP first page	33
Figure 22: – Saw blade thickness measure	34
Figure 23: – Saw blade thickness measured by caliper	34
Figure 24: – Save the saw thickness	35
Figure 25: – Zero point (24), Blade agents the cutting wood pieces	36
Figure 26: – Zero point, save the calibration point by selecting ‘Set 0 Position’	37
Figure 27: – Zero point, Move SIMONI Jig back and forth, check for friction between blade and wood being cut.	38
Figure 28: – ‘Set 0 Position’, automatically move the user to the ‘Cut Page’	38
Figure 29: – Plan information and Option	39
Figure 30: – reload and save option	40
Figure 31: – Start button moves the user to the next page	41
Figure 32: – ‘Start to Cut’ page, BOARD A as default as first, BOARD B complimentary picture	42
Figure 33: Busy box indication	43
Figure 34: – End Screw Indication, happens only when the user reaches the screw limit	43
Figure 35: – inside calibration page, software upgrade for Firmware and file system	44
Figure 35: – LED Blink	46

Table of Tables

Table 1 – SIMONI Jig Part Number (P.N) and relative description	8
Table 2 – Inside the Box items.....	23
Table 3 – LED indication scenario.....	45

1 Introduction

We have developed a groundbreaking electronic digital jig that revolutionizes the field of carpentry and woodworking. The jig easily solves one of the most complicated problems for wooden joints, of almost any type, in a very intuitive way for the user. It is controlled by a wireless application, making it easy to use and portable.

Concept Change

The jig breaks the mold of traditional, fully mechanical analog jigs on the market today. It is a hybrid product that combines a hardware aluminum jig with a software application. This allows for a more precise and versatile woodworking experience.

The ease of use is self-explanatory by the App



Figure 1: – Simoni Jig

2 Jig Legend

2.1 Jig Explorer parts

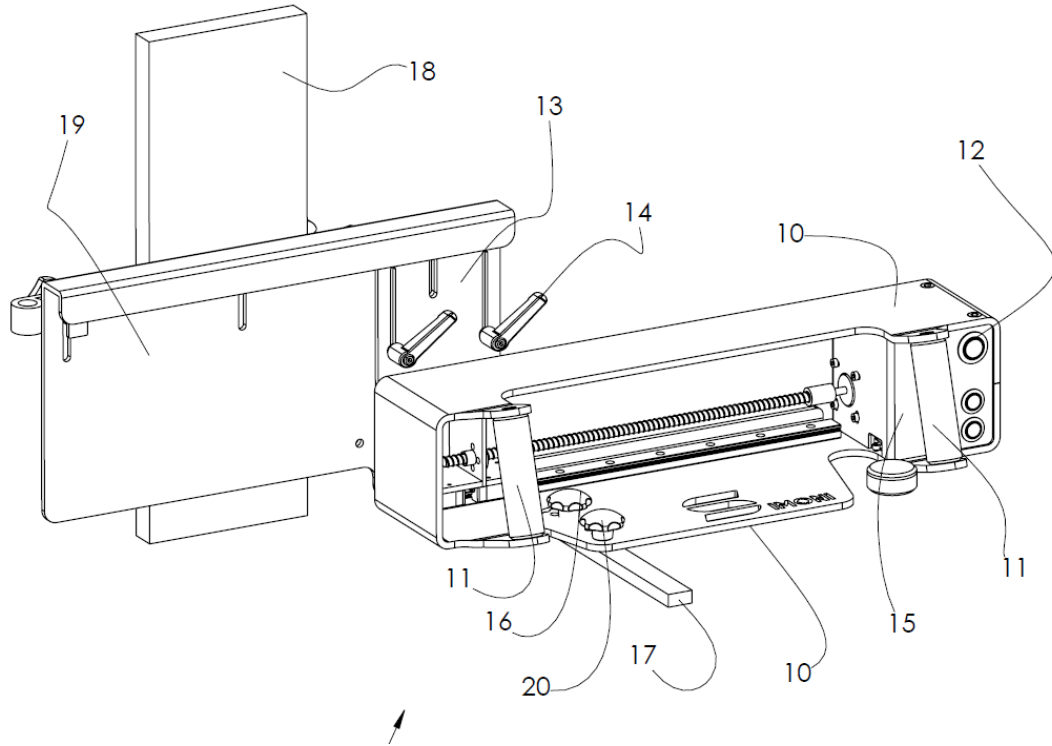

Figure 2: – List of the Jig parts (front)

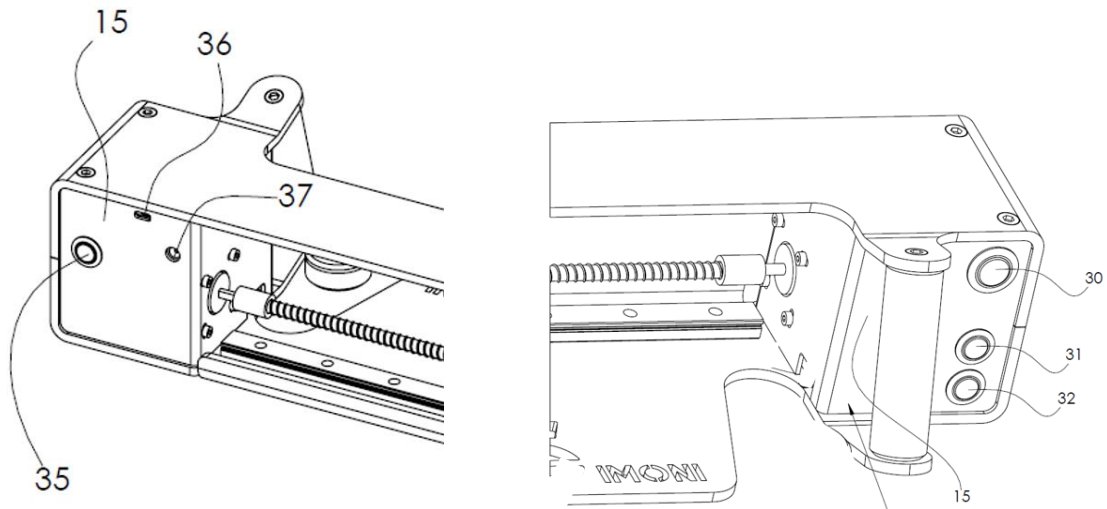

Figure 3: – List of the Jig parts (Electric Box Front and Rear)

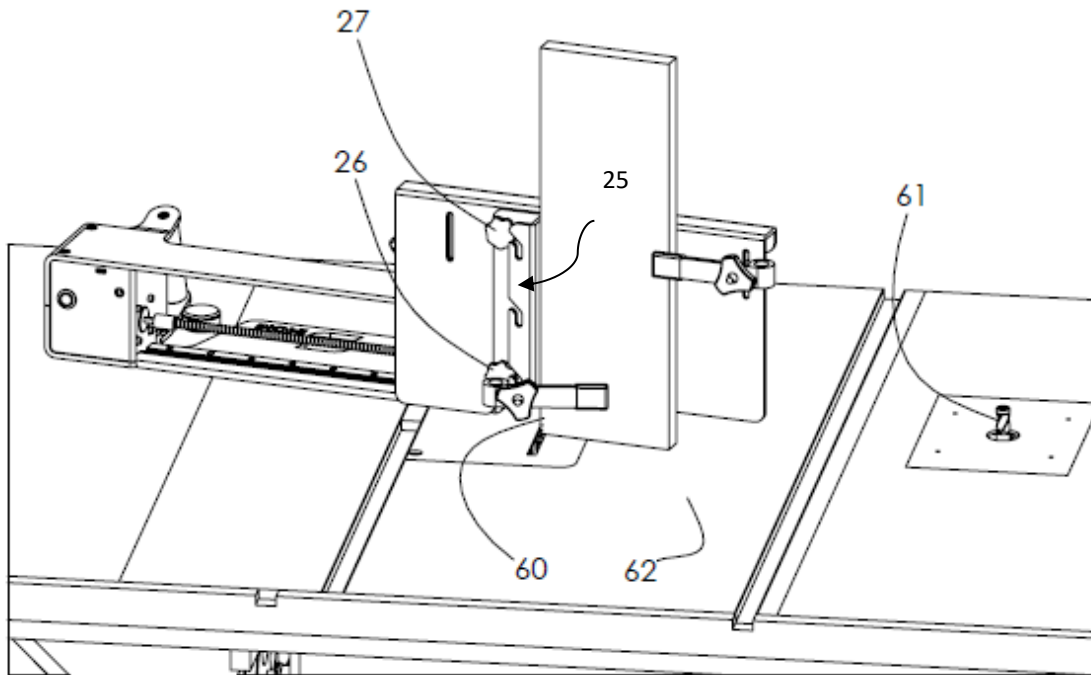

Figure 4: – List of the Jig parts (Electric Box)

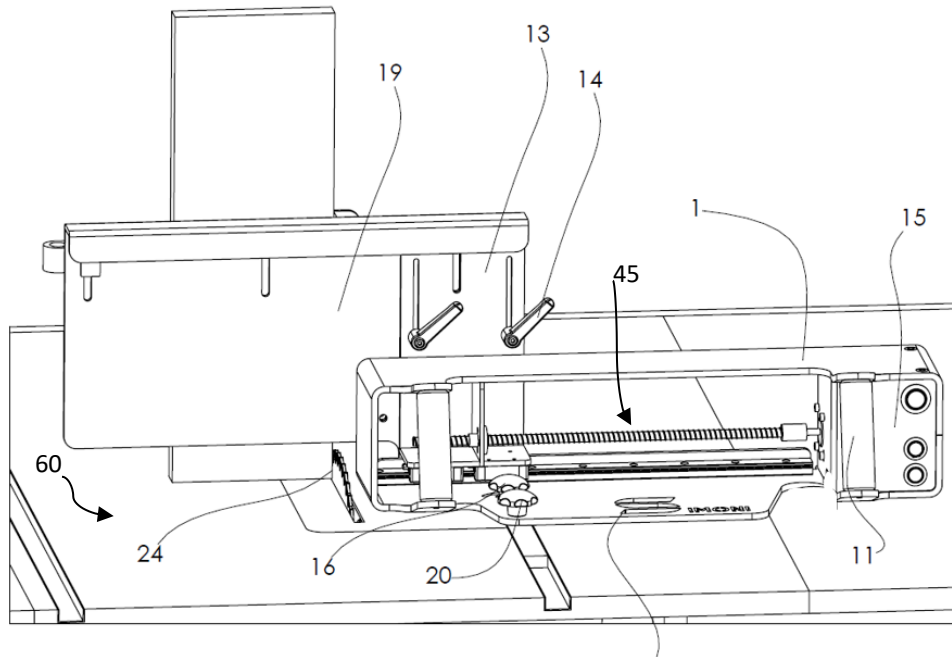

Figure 5: – Example of how to lay down the Jig on the cutting table



2.2 Jig Explorer Table

Part Number	Description / Name
10.	Main chassis
11.	Technical grip handles (held by the user while moving the system along a second axis)
12.	Analog control button – for reporting the completion of a cut iteration
13.	Fix Plate – movable (along the Z axis) about the material holder plate 19
14.	Ratchets for locking (after the height is set) the fixed plate to the material holder plate.
15.	An electronic system (includes the controller and may include a communication unit)
16.	The first knob – may move within a recess (formed in a base of the main chassis) about an axis defined by the second knob 20 - to determine the yaw angle.
17.	Leading rail – moves within the recess (not shown) while maintaining a yaw angle
18.	Cut element (first = A type ; or second = B type)
19.	Material Holding plate
20.	The second knob – yaw angle axis of rotation – may pass through an opening formed within the base of the main chassis.
24.	Zero Position between the cutting material and cutting tool Refers to a start position – in which the cut elements are aligned (has its edge contact a side of) the cutting element. The alignment process is also referred to as calibration.
25.	Linear fences hold the carting material
26.	The third knob – may move within a recess about an axis defined by the fourth knob 27 - to determine the roll angle
27.	The fourth knob – defined the roll angle axis of rotation

30.	Forward Analog Button – report completion of a cut iteration
31.	Backboard Analog Button – request to restart last cut iteration
32.	Home Analog Button – request to restart a formation of a requested pattern of recesses
35.	Power Button
36.	Technical Port (communication port)
37.	Power Jack
40.	Step Motor
41.	Linear Screw. The thread of the linear screw may have any cross-section – for example, a circular cross-section for increased movement accuracy.
42.	Coupling motor connector
43.	Anti-backlash element
44.	Rail Block
45.	Linear Rail that performs linear movement along the first axis as a result of the rotation of the linear screw
46.	Rail Block Combiner
60.	Circle Saw – an example of a cutting element –does not belong to the system

Table 1 – SIMONI Jig Part Number (P.N) and relative description



3 Safety Guide

3.1 General Instruction

This product is designed for specific applications as defined in the instructions. It should not be modified or used in any manner not described in these instructions. Only use recommended accessories.

Before using the SIMONI Jig, please read the instructions carefully and understand the safety warnings.

The SIMONI Jig is a powerful tool that can be dangerous if used incorrectly. By following the instructions and safety warnings, you can help to ensure your safety and the safety of others.

3.2 ***IMPORTANT SAFETY INSTRUCTIONS***

- Read, understand, and follow all instructions and safety warnings before using this product.
- Keep these instructions readily available for future reference.

Failure to follow these instructions could result in serious injury or death..

READ, UNDERSTAND, and FOLLOW ALL INSTRUCTIONS AND SAFETY WARNINGS. KEEP THESE INSTRUCTIONS READILY AVAILABLE FOR FUTURE REFERENCE.

3.3 Work area Safety

- A. Keep work area clean and well lit. Cluttered or dark areas invite accidents.
- B. Do not operate power tools in explosive atmospheres, such as in the presence of flammable liquids, gases or dust. Power tools create sparks which may ignite the dust or fumes.
- C. Keep children and bystanders away while operating a power tool. Distractions can cause you to lose control.



3.4 Electrical Safety

- A. Power tool plugs must match the outlet. Never modify the plug in any way. Do not use any adapter plugs with earthed (grounded) power tools. Unmodified plugs and matching outlets will reduce risk of electric shock.
- B. Avoid body contact with earthed or grounded surfaces, such as pipes, radiators, ranges and refrigerators. There is an increased risk of electric shock if your body is earthed or grounded.
- C. Do not expose power tools to rain or wet conditions. Water entering a power tool will increase the risk of electric shock.
- D. Do not abuse the cord. Never use the cord for carrying, pulling or unplugging the power tool. Keep cord away from heat, oil, sharp edges or moving parts. Damaged or entangled cords increase the risk of electric shock.
- E. When operating a power tool outdoors, use an extension cord suitable for outdoor use. Use of a cord suitable for outdoor use reduces the risk of electric shock.
- F. If operating a power tool in a damp location is unavoidable, use a RESIDUAL CURRENT DEVICE (RCD) protected supply. Use of an RCD reduces the risk of electric shock.

NOTE The term "RESIDUAL CURRENT DEVICE (RCD)" may be replaced by the term "ground fault circuit interrupter (GFCI)" or "earth leakage circuit breaker (ELCB)".

3.5 Personal Safety

- A. Stay alert, watch what you are doing and use common sense when operating a power tool. Do not use a power tool while you are tired or under the influence of drugs, alcohol or medication. A moment of inattention while operating power tools may result in serious personal injury.
- B. Use personal protective equipment. Always wear eye protection. Protective equipment such as a dust mask, non-skid safety shoes, hard hat or hearing protection used for appropriate conditions will reduce personal injuries.



- C. Prevent unintentional starting. Ensure the switch is in the off-position before connecting to power source and/or BATTERY pack, picking up or carrying the tool. Carrying power tools with your finger on the switch or energising power tools that have the switch on invites accidents.
- D. Remove any adjusting key or wrench before turning the power tool on. A wrench or a key left attached to a rotating part of the power tool may result in personal injury.
- E. Do not overreach. Keep proper footing and balance at all times. This enables better control of the power tool in unexpected situations.
- F. Dress properly. Do not wear loose clothing or jewellery. Keep your hair and clothing away from moving parts. Loose clothes, jewellery or long hair can be caught in moving parts.
- G. If devices are provided for the connection of dust extraction and collection facilities, ensure these are connected and properly used. Use of dust collection can reduce dust-related hazards.
- H. Do not let familiarity gained from frequent use of tools allow you to become complacent and ignore tool safety principles. A careless action can cause severe injury within a fraction of a second.

3.6 Power tool use and care

- A. Stay alert, watch what you are doing and use common sense when operating a power tool. Do not use a power tool while you are tired or under the influence of drugs, alcohol or medication. A moment of inattention while operating power tools may result in serious personal injury.
- B. Use personal protective equipment. Always wear eye protection. Protective equipment such as a dust mask, non-skid safety shoes, hard hat or hearing protection used for appropriate conditions will reduce personal injuries.
- C. Prevent unintentional starting. Ensure the switch is in the off-position before connecting to power source and/or BATTERY pack, picking up or carrying the tool. Carrying power tools with your finger on the switch or energising power tools that have the switch on invites accidents.



- D. Remove any adjusting key or wrench before turning the power tool on. A wrench or a key left attached to a rotating part of the power tool may result in personal injury.
- E. Do not overreach. Keep proper footing and balance at all times. This enables better control of the power tool in unexpected situations. Dress properly. Do not wear loose clothing or jewellery. Keep your hair and clothing away from moving parts. Loose clothes, jewellery or long hair can be caught in moving parts.
- F. If devices are provided for the connection of dust extraction and collection facilities, ensure these are connected and properly used. Use of dust collection can reduce dust-related hazards.
- G. Do not let familiarity gained from frequent use of tools allow you to become complacent and ignore tool safety principles. A careless action can cause severe injury within a fraction of a second.

3.7 Service

- A. Have your power tool serviced by a qualified repair person using only identical replacement parts. This will ensure that the safety of the power tool is maintained.

This document will be used with the following guide colors will be used with this document:



Danger Indicates an immediate hazard that, if not avoided, will result in death or serious injury. Must be obeyed.



Warning Indicates a potential hazard that, if not avoided, could result in death or serious injury.



Caution indicates a hazardous situation that, if not avoided, may result in minor or moderate injury or property damage.



The notice indicates important or helpful information and/or user tips.

3.7.1 Recent version

Always check the product page to make sure you are using the most recent version of the instructions and safety warnings for your product.

The instructions and safety warnings may change over time as the product is updated or new hazards are identified. By checking the product page regularly, you can ensure that you are always using the most up-to-date information and that you are taking the necessary precautions to stay safe.



3.7.2 Additional Tools

Before using another tool with this product, always read, understand, and follow the instructions and safety warnings in the owner's manual for that tool. If you do not have the owner's manual, contact the tool's manufacturer to obtain a copy.

This is important because each tool has its unique safety features and hazards. By reading the owner's manual, you can learn how to use the tool safely and avoid potential injuries.

3.7.3 Chemical/cleaning liquid

Before using any chemical with this product, always read, understand, and follow all safety warnings and guidelines in the manufacturer's Safety Data Sheet (SDS). manufacturer's Safety Data Sheet Personal safety equipment required to safely use the chemical (e.g. gloves, eye protection, mask/respirator, etc.) Proper and safe handling, storage, and disposal of the chemical.

The SDS will provide you with information on the chemical's hazards, how to use it safely (e.g. gloves, eye protection, mask/respirator, etc.), and how to handle, store, and dispose of it properly.

3.7.4 Using Third-party working tools

Before using this product, review and verify that all tools to be used with it have safety equipment installed and are in proper working order as defined by the tool's owner's manual.

Do not use this product until you have read and are confident you understand:

- Product Specific Warnings.
- Installing/Changing workpiece from A to B.

The user assumes all risk and responsibility for the proper and safe use of this product. This includes ensuring that the product is suitable for the



intended application and that all instructions and safety precautions are followed.

It is the sole responsibility of the purchaser of this product to ensure that anyone who uses this product reads and complies with all instructions and safety precautions outlined in this manual before use.

By following these safety precautions, you can help to prevent accidents and injuries when using this product.



Warning

Drilling, sawing, sanding, or machining wood products can expose you to wood dust, a substance known to the State of California to cause cancer. Avoid inhaling wood dust or use a dust mask or other safeguards for personal protection. For more information go to www.P65Warnings.ca.gov/wood.

4 Product Specific Warnings

Section Saw Table, general instruction safety instruction related to the cutting device using with SIMONI Jig, not part of the SIMONI product

4.1 Saw Table, general instruction

To avoid serious injury be aware of the following action:

DANGER

- keep hands and fingers away from the spinning saw.
- Maintain awareness of the saw at all times.



shutterstock.com - 1952328736

DANGER

- Stop the Saw before changing cut pieces from A to B (P.N 18 - [Figure 1](#))



4.2 SIMONI Jig Label instruction

Labeling index and description





Label picture	Label name	Label Description
	Keep heads on the handle all the time	During the operation of SIMONI Jig Keep your heads on the handle all the time (P.N 11, Figure 2)
	Keep fingers away from the spinning screw	During the operation of SIMONI Jig keep hands and fingers away from the spinning screw (P.N 45, Figure 2)
	Where to clamp	To prevent from clamp stuck in the machine body clamp only above this line How to Clamp
	Phone clamp area	Area to insert a phone holder for a better and useful JIG operation
	Read the User Manual	Please read carefully the user manual information before starting the work
	On \ Off button position	Indicate the power button stat position is On or Off
	Product information and power rating	

Table 2 – Label Product description

**⚠ CAUTION**

Before any work starts, verify the 'Material Holding plate' (P.N 19, [Figure 2](#)) is above the cutting blade, move the 'Material Holding plate' up and down With the knob ratchet (P.N 14, [Figure 2](#))

4.3 SIMONI Jig Note and Tips

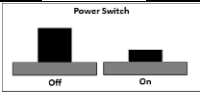
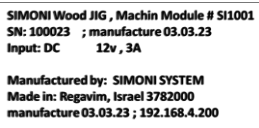
NOTICE

Only one device (Phone / PC / Tabulate) can connect to the SIMONI jig via the Application at a time to

5 Video User Guide

We highly recommend watching the video user guide before reading this manual. The video covers a recorded user guide on the calibration process, the SIMONI Jig operational process,

In addition, the video gives a lot of tips and how-to with live examples.

You can scan the code here or the code on the SIMONI Jig (left side) to enter the Video User guide



Figure 6: – Video User Manual and Support QR code

For any question/problem/thanks/improvement.

Please contact our support team at Support.Jig@simony.com or scan the support QR code.

6 Out Of Box Assembly

6.1 Assembly recommended tools

To assembly and calibrate the SIMONI Jig you will need the following 2 basic tools¹

1. 90-degree square tool



Figure 7: – 90-degree square tool

2. Caliper

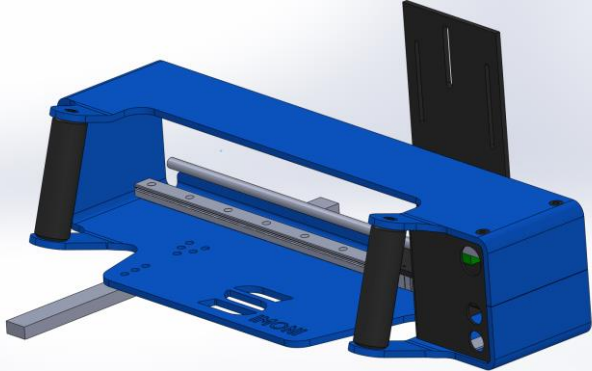
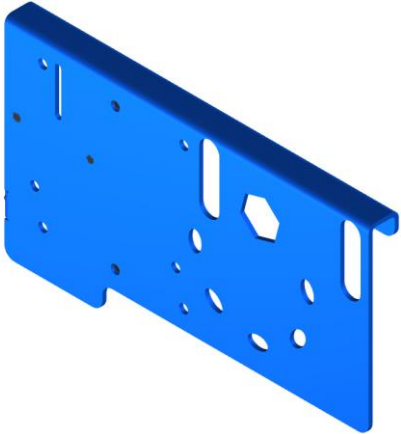
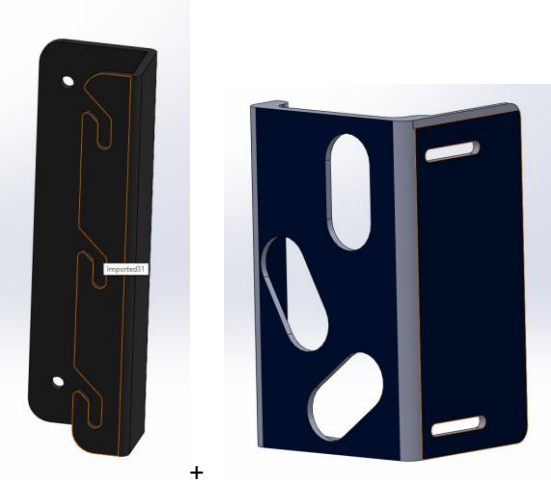

Figure 8: – Caliper

¹ Need to be purchase supertile

6.2 What you have inside the BOX

SIMONI Jig bundle includes:

-	Item Part Number P.N	Quantity	Picture
Main chassis	10	1	
Material Holding plate	19	1	
Linear fences	25	1+1	

Hand Fence	A	1	
Power Supply	01	1	
Leading Real	17	1	
Ratchets for locking	14	2	
Knob	16,27	4	

washer		6	
--------	--	---	---

Table 3 – Inside the Box items

6.3 Leading Rail Adjustment

Place the leading rail on the saw table slide, Make sure you close the rubbers that are responsible for the friction until the movement is free to the sides but at the same time there is a good sliding back and forth

You need to close only the upper screw in the beginning because when you assemble the SIMONI Jig this screw will not be available for adjustment (will be covered by the SIMONI Jig body)

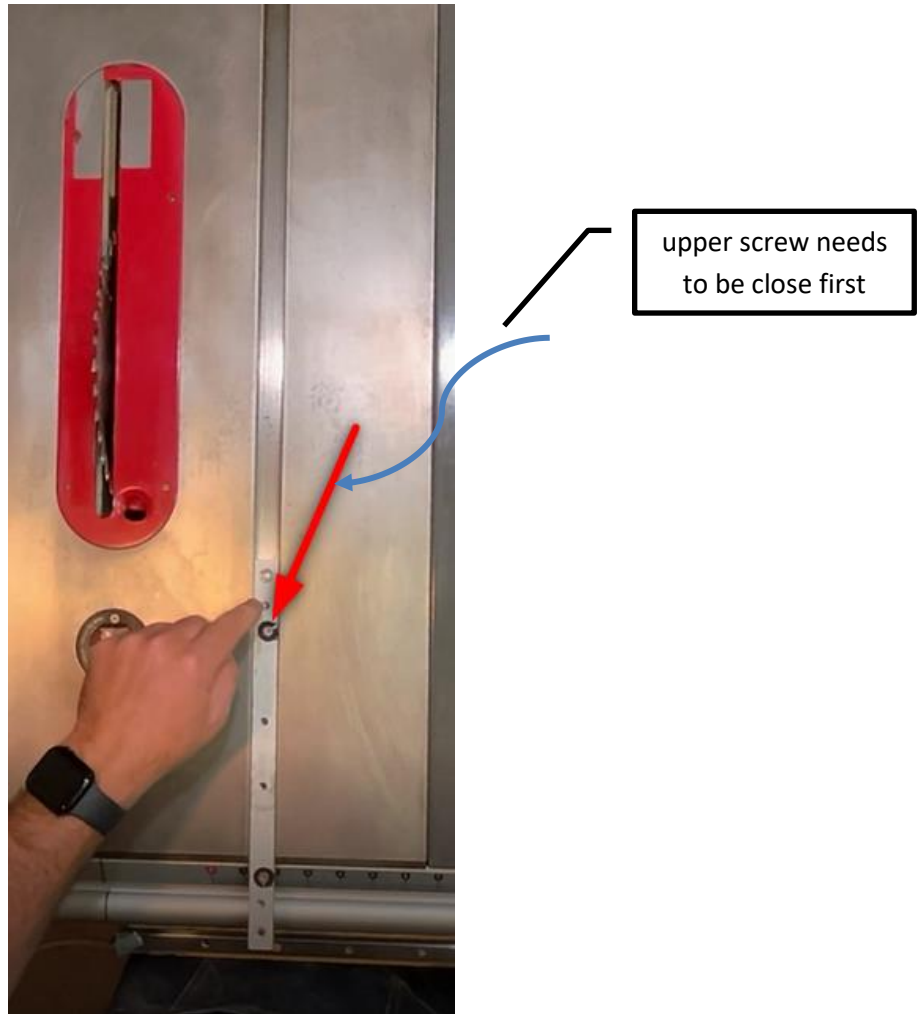
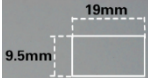

Figure 9: – leading rail, Adjustment

NOTICE

The size of the leading rail is  in rare cases 19mm needs to be sanded 0.1mm to fit correctly to the sliding hole in the saw table (depending on your table saw module)
removable of 0.1mm can be done with regular wood sandpaper

6.4 SIMONI Jig Position

After the leading rail is fitted to the sliding table rail, put the SIMONI Jig on the leading rail

1. Add watcher
2. Verify 90° between the Jig body and the leading rail (P.N. 17 [Figure 2](#))
Closed the knob after verifying 90°

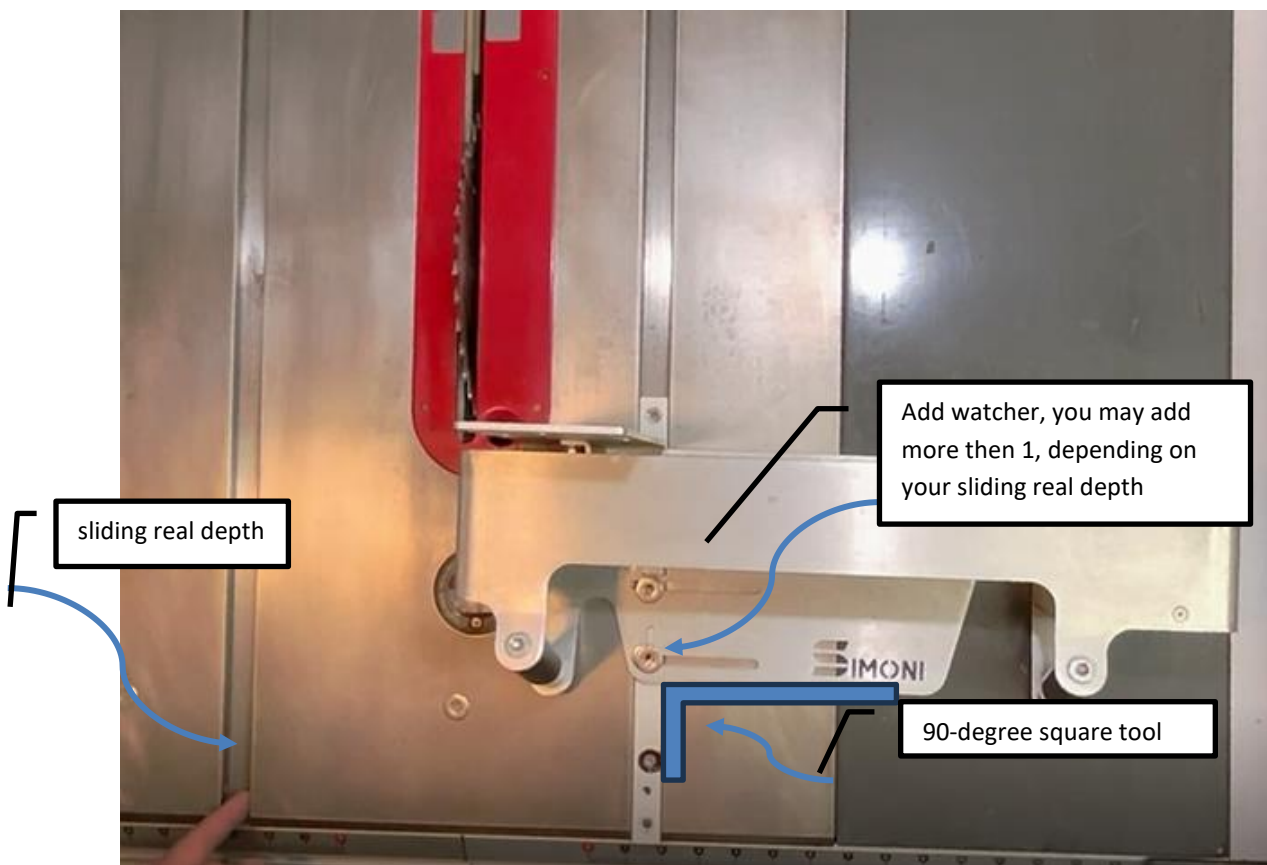

Figure 10: – SIMONI Jig body 90° setup



Figure 11: – SIMONI Jig body 90° calibrations done

6.5 Hand Fence

For extra protection and additional safety assembly the hand protection use the double-tape



Figure 12: – How to assembly the Hand Protection

6.6 Material Holding Plate Assembly

The last part that needs to be assembled is the Material Holding plate (P.N. 19 [Figure 2](#))

Adjust the height and verify you have a straight line with the SIMONI Jig frame

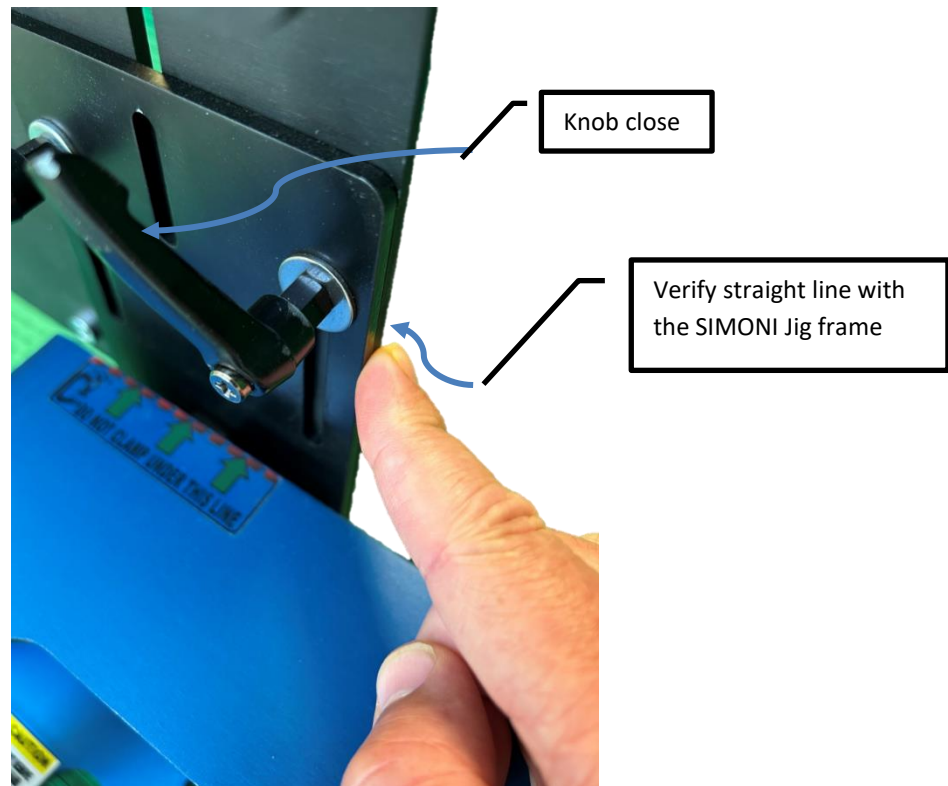

Figure 13: – close knob and straight line with the SIMONI Jig frame

⚠ CAUTION

Before any work starts, verify the ‘Material Holding plate’ (P.N 19, [Figure 2](#)) is above the cutting blade.

move the ‘Material Holding plate’ up and down

With the knob ratchet (P.N 14, [Figure 2](#))

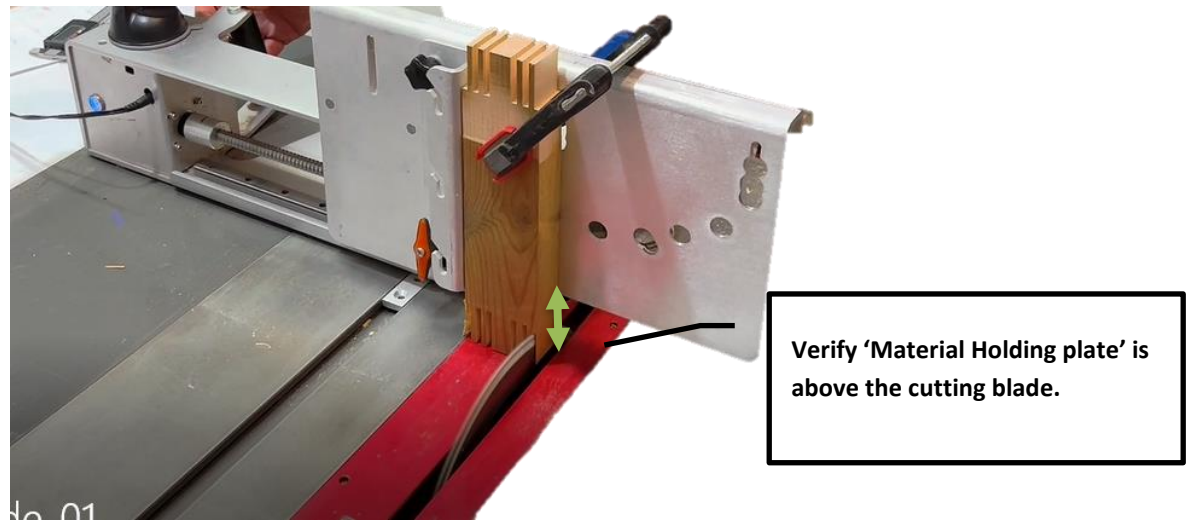

Figure 14: – verify Material Holding plate' is above the cutting blade.

6.7 Linear Fence Assembly



Figure 15: – linear fence assembly.

7 How to Clamp

There are several methods to clamp on the SIMONI Jig, to perform good clamp in all of the methods, is not to perform clam under the body of the machine

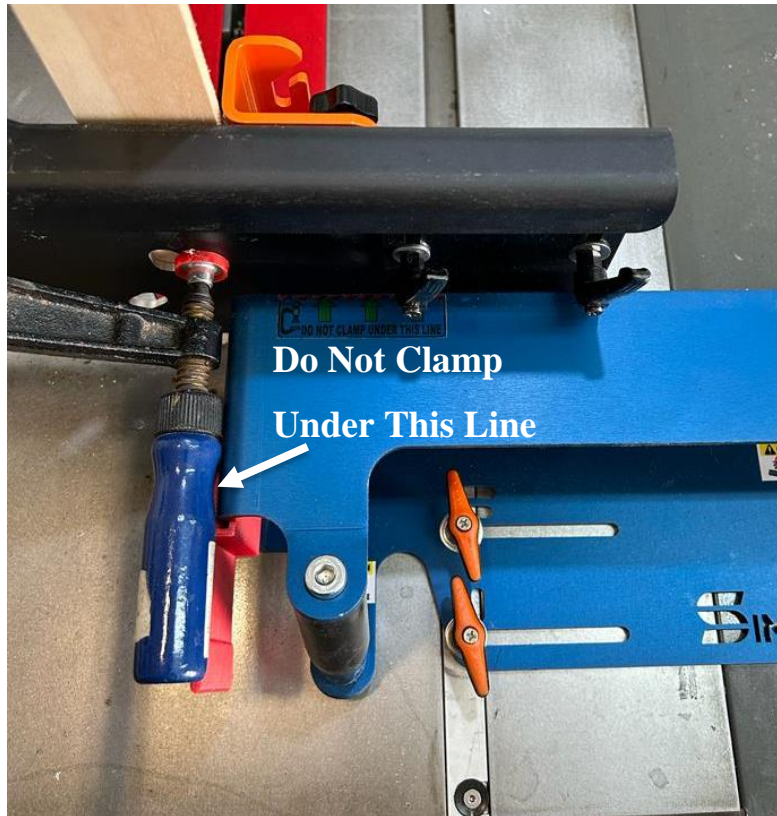

Figure 16: – incorrect Clamp, under the JIG body

Since, when the jig starts to move to the right, the clamp will get stuck in the machine body which can cause the jig to go out of calibration and cause inaccuracy in the cutting joint teeth



Figure 17: – Correct Clamp, several Method

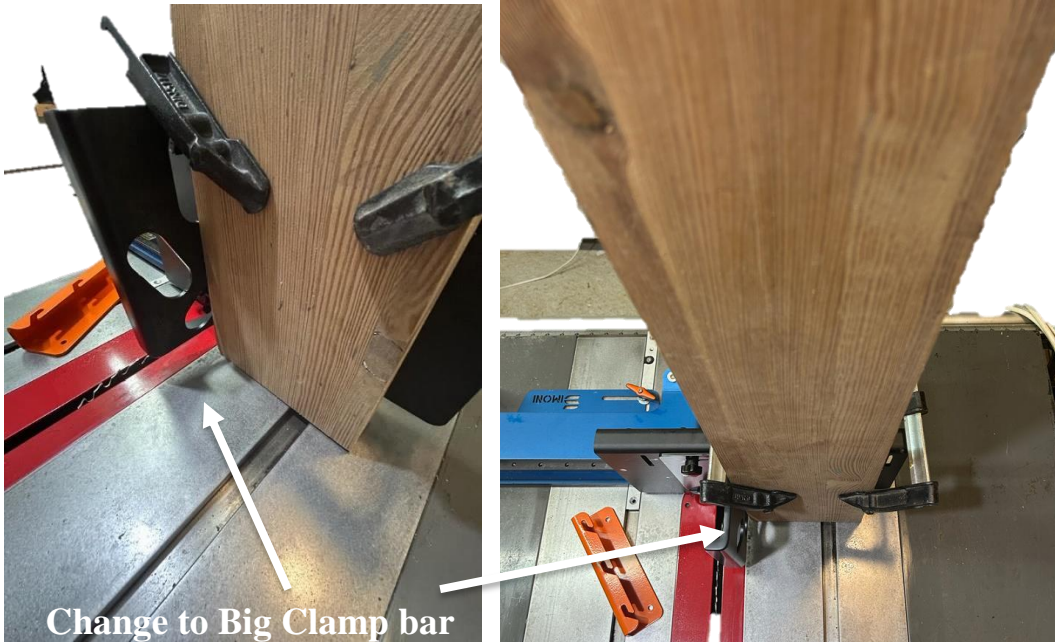

Figure 18: – Correct Clamp, the clamp has wood, change the clamp bar

8 Application explorer

8.1 General introduction

We Support Chrome Browser on Android and Apple

You have 3 simple steps to connect

8.2 Application connection

Step 1

To avoid disconnection for the Jig during the operation you need to forget/disconnect your current home or office network

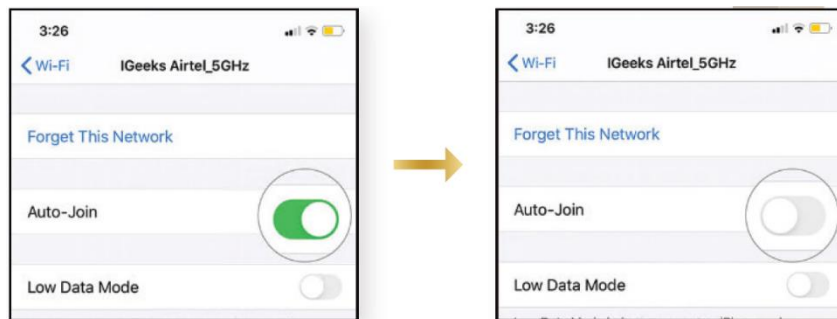

Figure 19: – forget your auto-connected network

Step 2

Search and select SIMONI's² network and connect³.



Figure 20: – SIMONI network selected and set for auto-reconnect

² Since this network does not have an outside internet connection, the OS can ask you if you want to connect to this kind of network – you need to answer YES

³ Only One device is allowed to connect to the Jig at a time

Step 3

After you connect⁴, scan the QR code.



Figure 21: – SIMONI APP to scan

You will automatically be redirected to the first page⁵

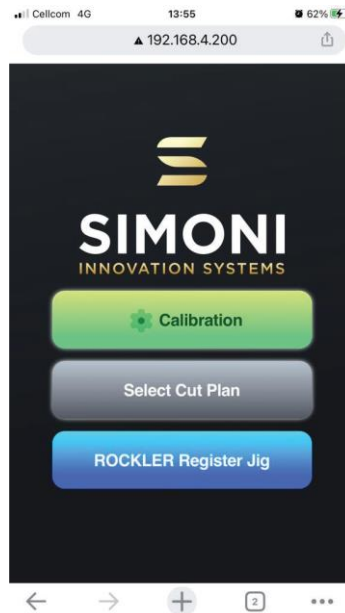

Figure 22: – SIMONI APP first page

⁴ * You don't need to wait for the blue checkmark (iPhone) to indicate the connection is completed

⁵ Faster work with Android device

8.3 Calibration process

On the calibration page, the user needs to make 2 actions

1. Enter 1 parameter: saw blade thickness,
2. move the SIMONI jig to the '0' (zero) point

8.3.1 Saw Blade Measure

please measure the blade thickness

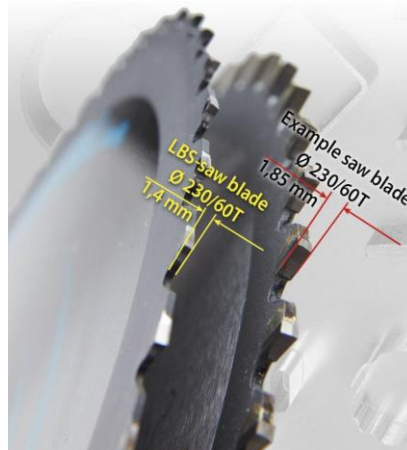

Figure 23: – Saw blade thickness measure

we recommended measuring the saw blade thickness with the caliber or taking it from the blade manufacturer's datasheet

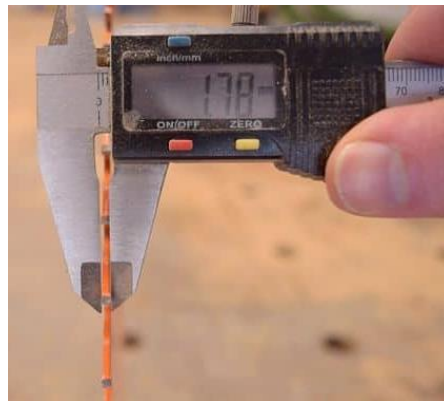

Figure 24: – Saw blade thickness measured by caliper

Enter the value of the measurement to the field in the application and select the measuring unit Inc or mm

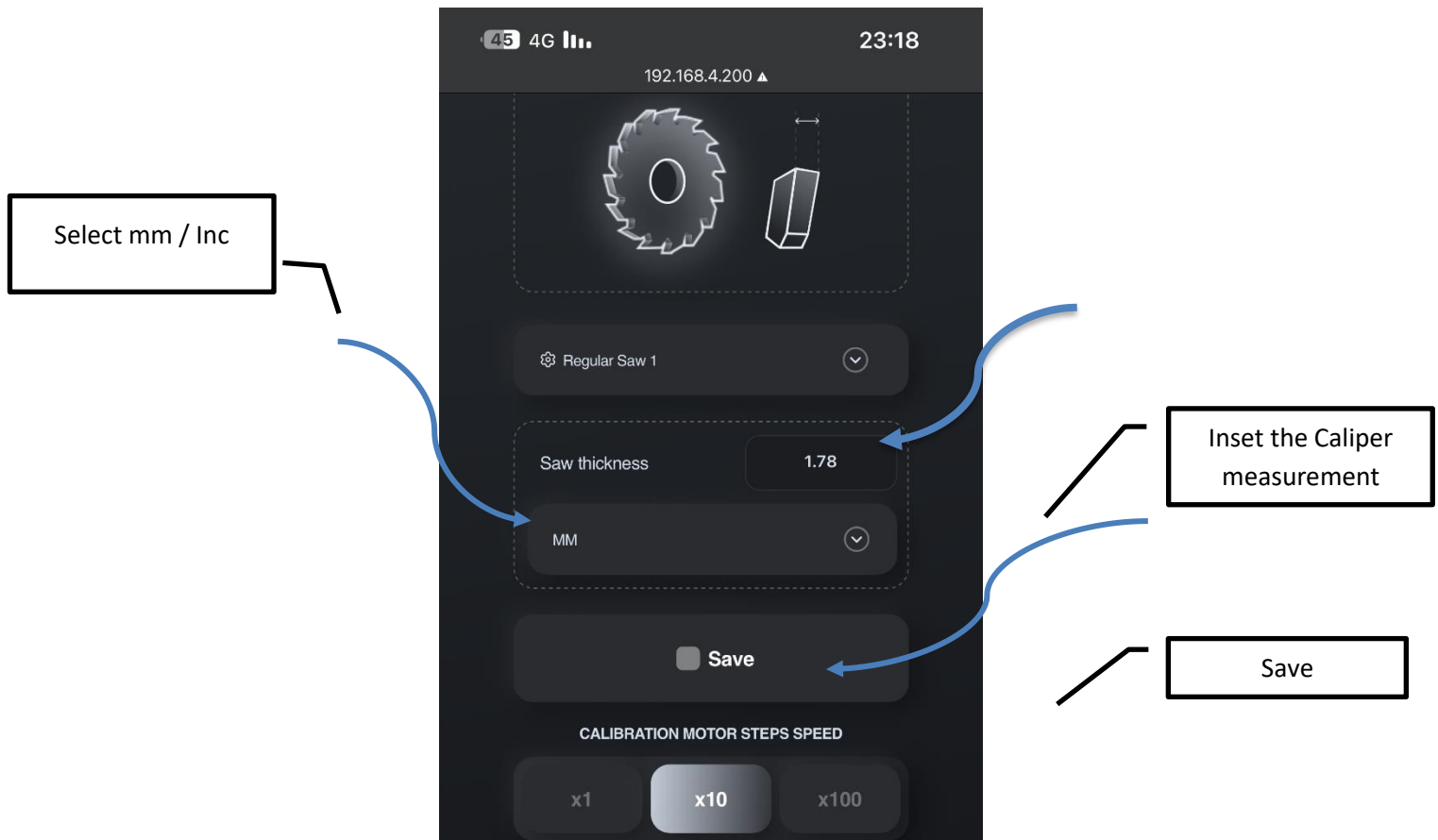

Figure 25: – Save the saw thickness

8.3.2 Zero Point Calibration

In the first use of the SIMONI jig, the user needs to calibrate the '0' zero point, the zero point determines agents Blade and the cutting wood pieces

NOTICE

The desired cutting wood pieces need to be from the left side of the cutting blade to avoid recalibration when replacing the blade

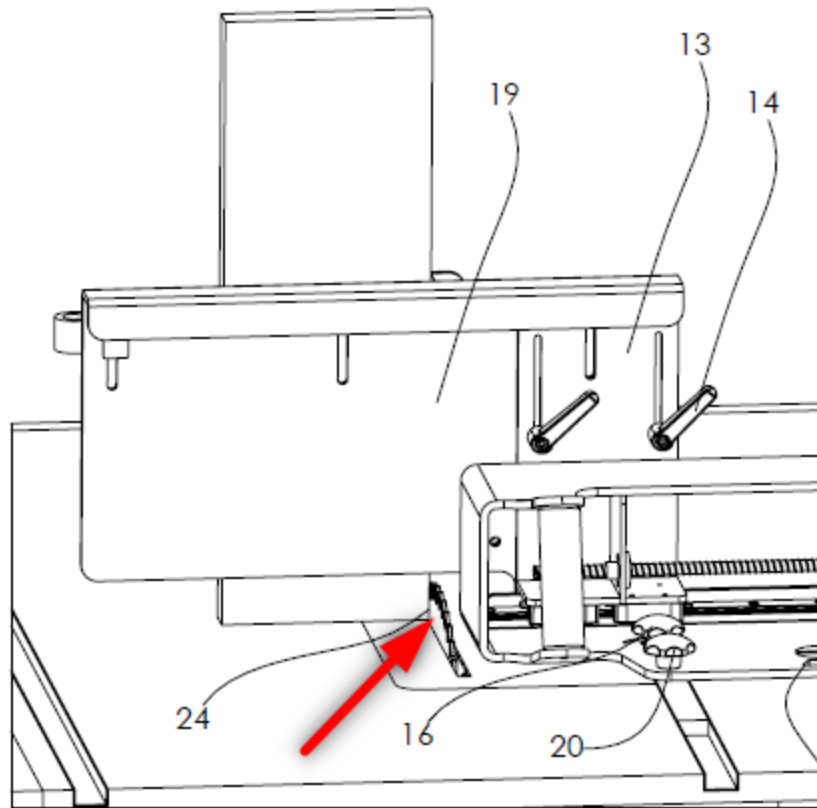

Figure 26: – Zero point (24), Blade agents the cutting wood pieces

This process needs to be done only one time during the work with the Jig⁶
 The calibration is done by selecting the step size to move left (away from the blade) or right (too close to the blade) by pushing on the Adjust Left and Adjust Right buttons see [Figure 27](#).

⁶ When the user changes a blade , the 0' point does not change and there is no need to recalibrate the 0 point , in this case, the user need to change the saw thickness value



Figure 27: – Zero point, save the calibration point by selecting 'Set 0 Position'

NOTICE

During the calibration process when the user pushes the Adjust Left and Adjust Right buttons, move the SIMONI Jig forward and backward on the leading rail (P.N 17 [Figure 2](#)) to verify the correct closeness to the cutting blade from the left side see [Figure 28](#)

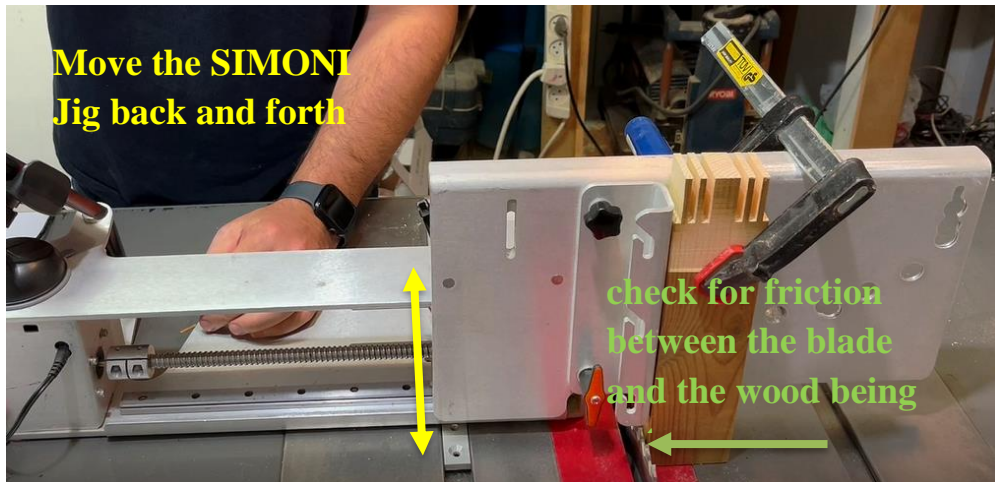

Figure 28: – Zero point, Move SIMONI Jig back and forth, check for friction between blade and wood being cut.

The calibration process is finished, and at the end of the process, the working pieces need to be tight against the cutting blade and yet, to move freely in front of the blade.

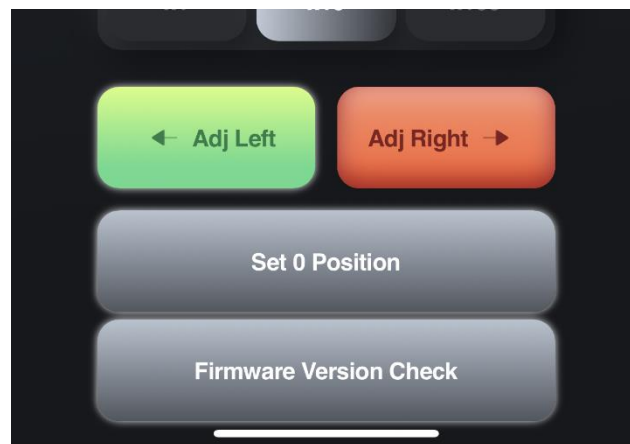

Figure 29: – ‘Set 0 Position’, automatically move the user to the ‘Cut Page’

When pushing on the ‘**Set 0 Position**’ button, the user is automatically redirected to the next page – to select the cutting plan

8.4 Start to cut

On this page the user chooses the type of design for cutting, there are several programs and it is possible to download additional libraries for cutting.

After selecting the program, a screen will open for entering parameters. The parameters are very simple and indicate the basic sizes of the cut part

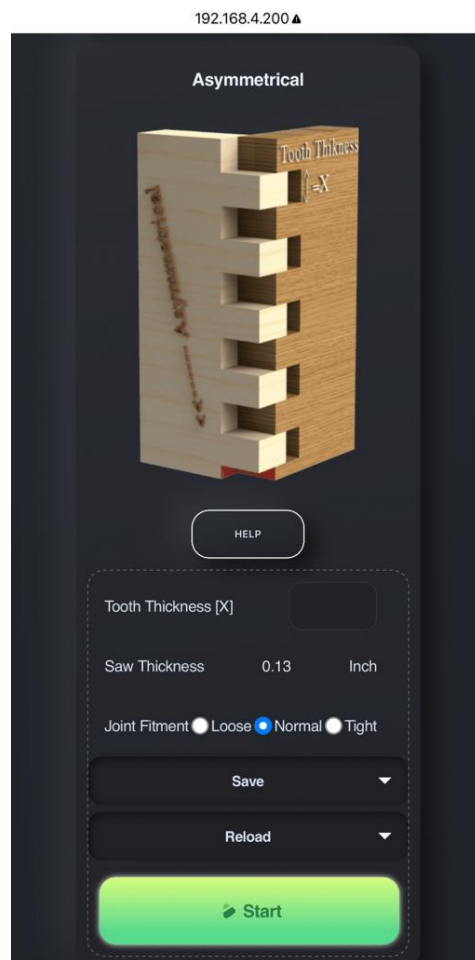
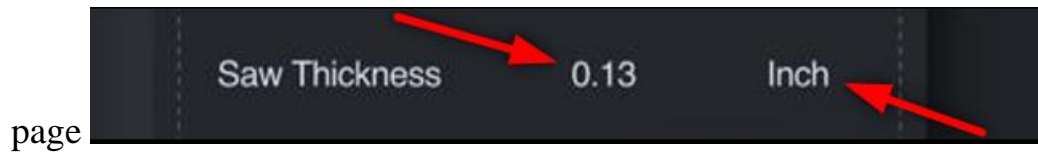

Figure 30: – Plan information and Option

For each program, you have the following information/option:

1. Saw thickness and the unit (mm or Inch) user inserts on the calibration



2. Select the Joint Fitment, What is the level of friction between the plates, Part A and Part B of the cutting piece, the user can select 3 types of friction **Loss, Normal, and Tight**.

The default parameter is normal

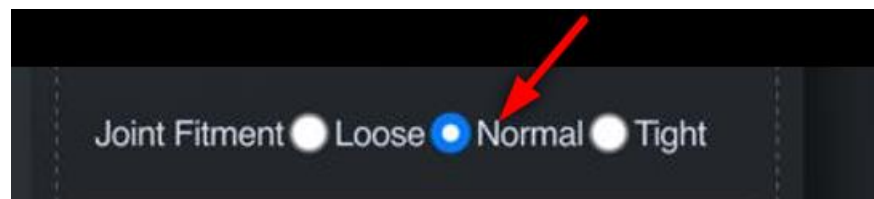

3. Save the program parameter

4. Reload the saved plan

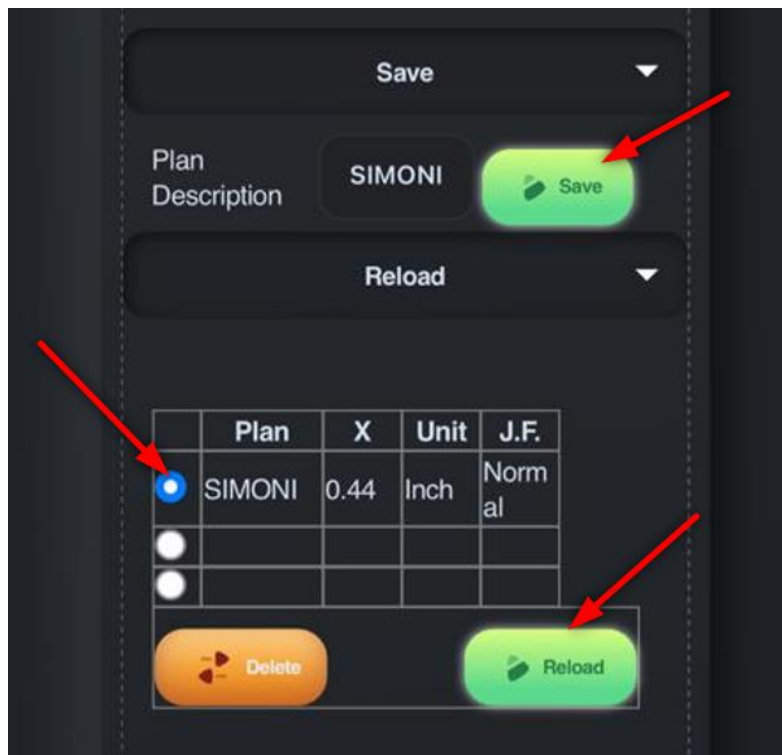

Figure 31: – reload and save option

The user can save the plan values for quick repetitive cutting, It is possible to save up to 3 programs for each design, if you are interested in more than 3 programs, you must select the program you want to delete, delete it, and save the new data.

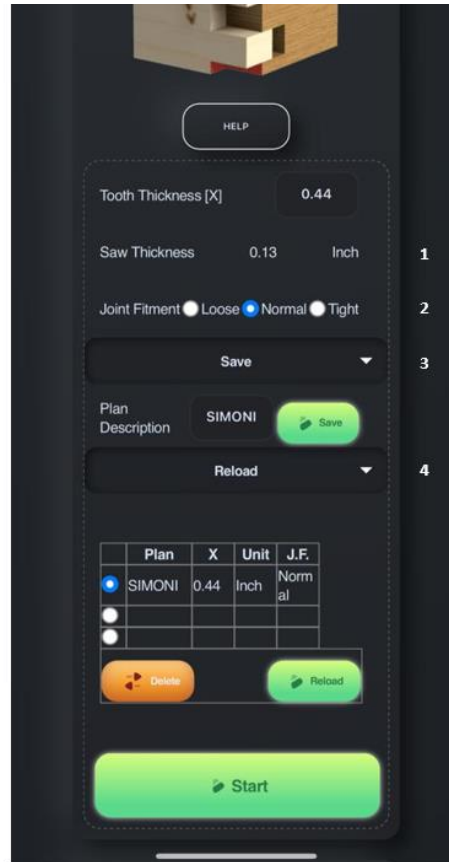

Figure 32: – Start button moves the user to the next page

8.5 Start to cut

Once the program is selected, the user automatically goes to the cutting page.

The program is stored in the SIMONI Jig computer, the user can choose to activate the SIMONI Jig from the analog buttons on the body of SIMONI Jig or the application or alternately (analog button and application)

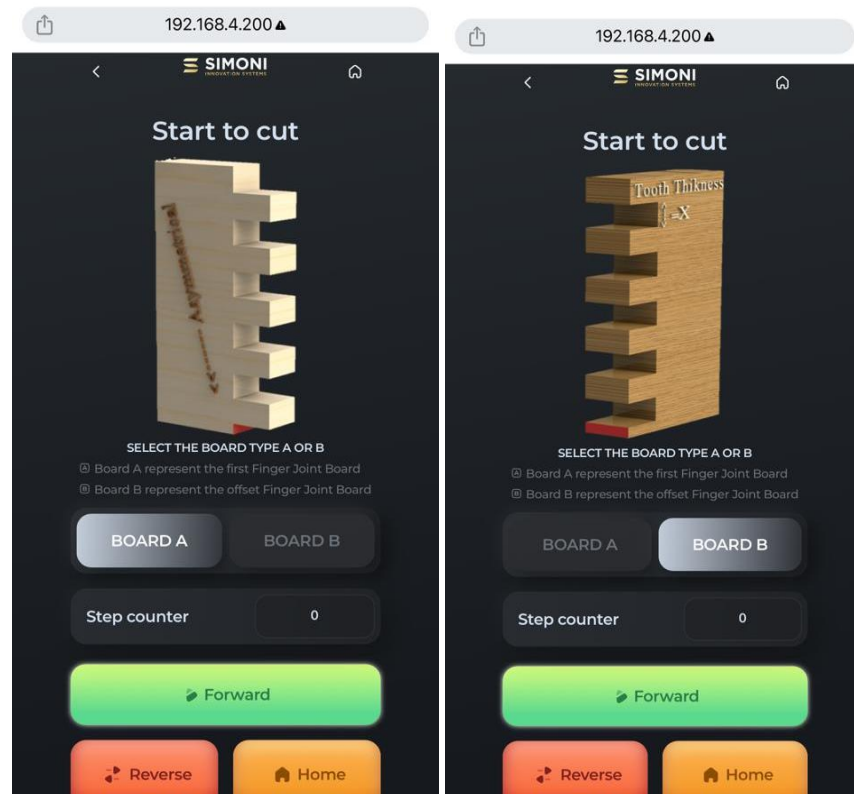

Figure 33: – 'Start to Cut' page, BOARD A as default as first, BOARD B complimentary picture

For the 'Start to Cut' page user has the following information/option:

1. Selecting BOARD A or BOARD B, the picture will change accordingly
 - a. by selecting a different board type the SIMONI Jig returns to home (0 point position)
2. **The forward button** moves the cut piece to the right, one step the time
3. **The Revers button** moves the cut piece to the left, one step at a time



4. **The Home button** moves the cut piece to the left, no stop immediately return to the home position
5. **Busy indication** – when SIMONI Jig moves, a Busy box indication will appear on the screen, during this time all the pushed buttons are out of function, and no response

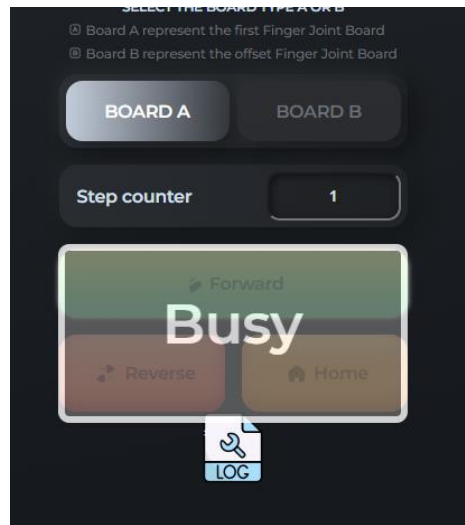

Figure 34: Busy box indication

6. **End Screw** – when SIMONI Jig moves to the end of the screw length, an 'End Screw' box indication will appear on the screen, during this time the **Forward button** is out of function, the user can be used with the **Revers button**, or the **Home Button** only

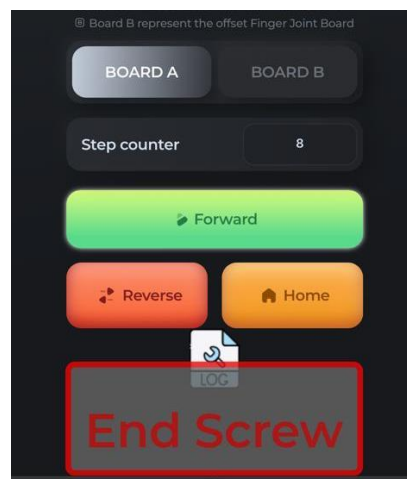

Figure 35: – End Screw Indication, happens only when the user reaches the screw limit



8.6 Software upgrade and verify the latest FW version

SIMONI Jig can upgrade the SW over the air

4 steps:

1. Closed all your application and browser pages
2. Save the new file version on your laptop (preferred method) or on your Phone
3. Connect to the SIMONIY Jig, browse to the main page, and select the **calibration**

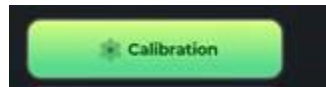

scroll down to



You will enter the FW upgrade page, verify your current version number, If the current version is greater than the version you want to upgrade - **don't do an upgrade**

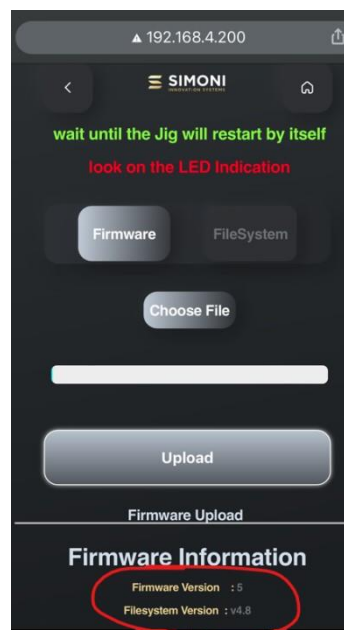

Figure 36: – Inside the calibration page, the software upgrade for Firmware and file system

4. Select first the **firmware button** (file name to select **firmware.bin**) -- **Do not leave or refresh the Page Until the LED indication on the JIG blink**
5. Second, select the **FileSystem button** (file name to select **littlefs.bin**) -- **Do not leave or refresh the Page Until the LED indication on the JIG blink**

Verify the software version is changed and that you have a bigger number

8.7 LED indication

The table below lists the Led Indication scenario, the indication gives the user additional feedback during the work





Led Status	Indication	Comment
	Hello, BOOT	During the BOOT, the SIMONI Jig will be signaling Hello word in Morse code
	Busy, forward, reverse	During the motor movement, the LED indicates on busy state until the motor movement stops
	Return Home	Pushing on the home button or changing the board cut type from A to B, the JIG will return home
	SW Upgrade completed	After the user finishes upgrading the SIMONI Jig with the new version Success upgrade indicated the return home blink + hallo blink
	End of Screw	Solid LED light, until the user returns home Or revers Or boot

Table 4 – LED indication scenario

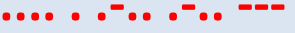

Figure 37: – LED Blink

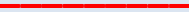

9 Troubleshooting and contact

9.1 Help Scenario

Topics	Scenario	How to solve	comment
Connection	The APP does not reload completely	Go to section 8.2 Application explorer	During the connection, some of the phones show "No Internet Connection" message – this is ok, the SIMONI Digital Joints System does have internet
Connection	The APP does not reload completely	Go to section 8.2 Application explorer	forget/disconnect your current home or office network
Connection	Connection refuse message on the OS / Android system	Disconnect the other device from the SIMONI Digital Joints System	Only 1 connection to the SIMONI Digital Joints System is allowed for parallel
Connection	Disconnection during the work	Verify that the 12v cable is free from obstacles	When you move the SIMONI Digital Joints System forward and backward, Verify that the 12v cable is secure
Home Position	SIMONI Digital Joints System Not returning to home	Verify the power is on and the 12v cable is connected	Verify the lead screw is free from wood chips
Home Position	Loud noise of screw sliding \ can't move forward	End of screw travel , push on the HOME button	Verify the clamped wood to not too heavy and It has no friction with the surface of a saw table
Home Position	SIMONI Digital Joints System Not returning to home	When pushed on the home button, LED blink and the system is not moving – recalibration is needed	You can move the system by hand, turn off the SIMONI Digital Joints System, scrolled the screw to the home position and turn on the SIMONI Digital Joints System (see Zero Point Calibration)
Unmatching between pieces	Cut truth is not equal	Verify you position Board A and Board B on the same side	Both A and B pieces need to be held on the same side against the clamp bar
unmatching between pieces	Board A and Board B are not matching	Please send a picture and your cut plan values to the support team	We will do our best to send you updated SW ASAP



9.2 How to contact, our address and feedback

For any additional information please get in touch with our support team

Business information:

Email: Support.jig@simoniy.com

Name: SIMONI SYSTEMS

Address: Regavim, Israel Zip 3782000

Tel / WhatsApp: 972507815636